

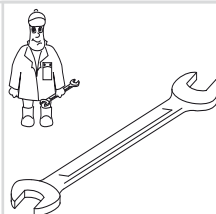

Gebr. Becker GmbH
Hölker Feld 29-31
D-42279 Wuppertal

Wartung
Maintenance
Entretien
Manutenzione
Mantenimiento



	Pos.	Menge ²⁾ Quantity Quantité Quantità Cantidad	Bestell-Nr. Ident No. No. Identification No. Identificazione No. de pedido	Bezeichnung Description Designation Designazione Descripción
KDT 3.60 - 3.80	...	1	549000 21100	Dichtungssatz, Complete set of seals, Jeu de joints, Kit di guarnizioni, Junta Completa
	11	SATZ (KIT)	901330 00004	Schieber, Rotor Vane, Palette, Empujador
	11	SATZ (KIT)	901379 00004	" KDT 3.60/0-52 + KDT 3.80/0-52
	11	SATZ (KIT)	"	" KDT 3.60/6 + KDT 3.80/6
	11	SATZ (KIT)	901379 00007	" KDT 3.60/6-29
	68	1	909507 00000	Filterpatrone, Filter cartridge, Cartouche Filtrante, Cartuccia filtro, Cartucho de filtro
	68	1	909587 00000	" KDT 3.60/6 + KDT 3.80/6
	91	1	909510 00000	Filterpatrone, Filter cartridge, Cartouche Filtrante, Cartuccia filtro, Cartucho de filtro

²⁾ erforderliche Bestellmenge / necessary order quantity / quantité nécessaire / quantità di ordinazione necessari / cantidad necesario



Ersatzteilliste
Spare parts list
Liste de pièces de rechange
Listino pezzi di ricambio
Lista de piezas de recambio
Lista de peças sobresselentes
Reserveonderdelenlijst
Reservedelsliste
Reservdelslista

Reservedelsliste
Varaosaluettelo
Wykaz części zamiennych
Seznam náhradních dílů
Tartalékalkatrész lista
Κατάλογος ανταλλακτικών
Перечень запасных частей
备用零件目录
スペアパーツリスト

KDT 3.60
KDT 3.80



28000021601 07/2009

Index-D

<p>SERVICE</p>	<p>Qingsu - PR CHINA www.becker-international.com</p>	year <input type="text" value="XXXX"/> No <input type="text" value="D"/>	Index Option
	type <input type="text" value="KDT 3.60-XX"/>	<input type="checkbox"/> CE	
	frequency <input type="text" value="XXXX"/> Hz		
	speed <input type="text" value="XXXX"/> min ⁻¹		
	power required <input type="text" value="XXXX"/> kW		
	inlet capacity <input type="text" value="XXXX"/> m ³ /h		
	pressure + <input type="text" value="XXXX"/> mbar		
	vacuum - <input type="text" value="XXXX"/> mbar		

D Service:
Tel: +49 (0)202 697-171
Fax: +49 (0)202 64 44 74
E-Mail: info@becker-international.com
www.becker-international.com



KDT 3.60 - 3.80

Pos.	Bestell Nr.	Beschreibung	
...	549000 21100	DICHTUNGSSATZ ¹⁾	
6	000100 21600	GEHÄUSE, KDT 3.60	
6	000100 21100	GEHÄUSE, KDT 3.80	
9	020004 21100	KOLBEN	
11	901330 00004	SCHIEBER (SATZ) ²⁾	
15	000801 21100	SEITENDECKEL	
16	000701 21100	SEITENDECKEL	
18	001100 21100	LAGERDECKEL A-SEITE	
19	001000 21100	LAGERDECKEL B-SEITE	
20	025511 21100	DICHTUNG	
24	911312 00000	DICHTUNGSSCHLAUCH	
26	917152 00000	AUSGLEICHSCHEIBE	
27	906540 00000	WELLENDICHRING	
28	906612 50000	WÄLZLAGER 3205 2RS C3 TA	
29	906657 00000	WÄLZLAGER NU 205/ZS	
31	511400 10100	SATZ DISTANZSCHEIBEN	
37	945217 00000	SECHSKANTSCHRAUBE	
38	016801 21100	SPANNSCHEIBE	
39	949807 00000	SENKSCHEIBE	
41	945224 00000	SECHSKANTSCHRAUBE	
42	945222 00000	SECHSKANTSCHRAUBE	
45	948742 00000	PASSKERBSTIFT	
47	947736 00000	PASSFEDER	
50	053201 21100	LATERNE	
52	950308 00000	UNTERLEGSCHNEIBE	
53	945337 00000	INNENSECHSKANTSCHRAUBE	
57	949409 00000	UNTERLEGSCHNEIBE	
58	945270 00000	WELLENENDSCHRAUBE	
61	040101 21100	FILTERGEHÄUSE	
62	025501 21100	DICHTUNG	
64	946955 00000	STIFTSCHRAUBE	
65	951003 00000	STIFTSCHRAUBE	
67	964407 00000	SCHALLDÄMPFERROHR	
68	909507 00000	FILTERPATRONE C 1112/2 (1x) ²⁾	
71	009000 27000	ANPRESSFEDER	
72	948750 00000	BLINDNIET	
73	040201 21100	FILTER-DECKEL	
75	025518 21100	DICHTUNG	
76	025516 21100	DICHTUNG	
77	022802 21100	FILTERTRÄGER	
79	945321 00000	INNENSECHSKANTSCHRAUBE	
80	946971 00000	STIFTSCHRAUBE	
81	947504 00000	UNTERLEGSCHNEIBE	
82	947104 00000	SECHSKANTMUTTER	
83	952019 00000	SPANNHÜLSE	
85	025514 21100	DICHTUNG	
86	025515 21100	DICHTUNG	
88	560203 21100	KÜHLER	
91	909510 00000	FILTERPATRONE C 713 (1x) ²⁾	
93	946965 00000	STIFTSCHRAUBE	
94	947105 00000	SECHSKANTMUTTER	
95	949450 00000	U-SCHNEIBE	
97	950304 00000	U-SCHNEIBE	
98	945322 00000	INNENSECHSKANTSCHRAUBE	
103	068801 21100	DECKEL	
104	025513 21100	DICHTUNG	
105	945319 00000	INNENSECHSKANTSCHRAUBE	
110	921500 50000	HANDGRIFF	
121	560204 21100	KÜHLER	
125	025504 21100	DICHTUNG	



KDT 3.60 - 3.80

Pos.	Bestell Nr.	Beschreibung	
126	025512 21100	DICHTUNG	
127	025517 21100	DICHTUNG	
129	945372 00000	INNENSECHSKANTSCHRAUBE	
130	945328 00000	INNENSECHSKANTSCHRAUBE	
132	946930 00000	STIFTSCHRAUBE	
134	005602 21100	DECKEL	
141	016606 21100	ANSCHLUSS-STÜCK	
146	025507 21100	DICHTUNG	
148	945368 00000	INNENSECHSKANTSCHRAUBE	
149	741310 30000	GUMMIPUFFER	
161	918300 21100	ABDECKHAUBE	
163	920800 21100	LUFTLEITHAUBE	
165	960700 21100	LÜFTERHAUBE	
166	960701 21100	LÜFTERHAUBE	
170	945321 00000	INNENSECHSKANTSCHRAUBE	
171	945371 00000	INNENSECHSKANTSCHRAUBE	
173	949806 00000	SENKSCHEIBE	
174	951703 00000	FEDERSCHNEIBE	
175	741302 00000	GUMMIPUFFER	
176	945634 00000	GEWINDESTIFT	
178	951602 00000	RINGMUTTER	
182	014902 21100	ZWISCHENFLANSCH	
184	951916 00000	KABELTÜLLE	
185	948772 00000	ROHRNIETE	
186	947508 00000	UNTERLEGSCHNEIBE	
188	945333 00000	INNENSECHSKANTSCHRAUBE	
190	951018 00000	STIFTSCHRAUBE	
191	947506 00000	UNTERLEGSCHNEIBE	
192	947106 00000	SECHSKANTMUTTER	
195	902108 00000	KUPPLUNGSHÄLFTE (MOT)	
196	902209 00000	KUPPLUNGSSCHNEIBE / GELB	
197	544501 21100	GEBLÄSEKUPPLUNG MIT VENTILATOR	
285	728000 99622	DRUCKREGULIERVENTIL / 0,6 BAR	
285	728001 99622	DRUCKREGULIERVENTIL / 1,0 BAR	
285	728002 99622	DRUCKREGULIERVENTIL / 2,0 BAR	
288	948066 00000	DICHRING	
290	964307 00000	SCHALLDÄMPFERROHR	
291	912805 00000	VERSCHLUSS-STOPFEN	
400	769302 40840	FREQUENZUMFORMER	
401	961301 19600	DICHTUNG	
402	945315 00000	INNENSECHSKANTSCHRAUBE	



LAGERFETT 960000 02300 AMBLYGON TA15/2 (TUBE, 8g)

¹⁾ Dichtungssatz - 54900021100 - Pos.: 20, 24, 62, 75, 76, 85, 86, 104, 125, 126, 127, 146, 288
²⁾ erforderliche Bestellmenge / Wartung

OPTIONAL

KDT 3.60	USA	alle Ausführungen
KDT 3.80	/0-05	Sonderausführung - Korrosionsschutz
	/0-34	Sonderausführung - > Fördermenge
	/0-52	Sonderausführung - Korrosionsschutz und Spezialschieber
	/0-54	Sonderausführung - Kühlung
	/0-400	Sonderausführung - mit Frequenzumrichter
	/6	Sonderausführung - Korrosionsschutz
	/B5-200	Sonderausführung - Motoranschluß

Abweichende Positionen zum Standardgerät - siehe Anhang (Zeichnungsrückseite)





KDT 3.60 - 3.80

Pos.	Ident No.	Description	
...	549000 21100	SET OF SEALS ¹⁾	
6	000100 21600	PUMP BODY, KDT 3.60	
6	000100 21100	PUMP BODY, KDT 3.80	
9	020004 21100	ROTOR	
11	901330 00004	CARBON VANES (KIT) ²⁾	
15	000801 21100	LID	
16	000701 21100	LID	
18	001100 21100	BEARING COVER	
19	001000 21100	BEARING COVER	
20	025511 21100	GASKET	
24	911312 00000	SEAL	
26	917152 00000	COMPENSATING DISC	
27	906540 00000	SHAFT-SEALING RING	
28	906612 50000	BALL BEARING	
29	906657 00000	BALL BEARING	
31	511400 10100	SET DISTANCE DISC	
37	945217 00000	HEX HEAD SCREW	
38	016801 21100	CLAMPING DISC	
39	949807 00000	SCREW	
41	945224 00000	HEX-HEAD SCREW	
42	945222 00000	HEX-HEAD SCREW	
45	948742 00000	STRAIGHT PIN	
47	947736 00000	KEY	
50	053201 21100	CONNECTION FLANGE	
52	950308 00000	WASHER	
53	945337 00000	SOCKET HEAD SCREW	
57	949409 00000	WASHER	
58	945270 00000	SHAFT END BOLD	
61	040101 21100	FILTER HOUSING	
62	025501 21100	GASKET	
64	946955 00000	STUD	
65	951003 00000	STUD	
67	964407 00000	SILENCER TUBE	
68	909507 00000	FILTER CARTRIDGE C 1112/2 (1x) ²⁾	
71	009000 27000	LEAF SPRING	
72	948750 00000	BLIND RIVET	
73	040201 21100	FILTER-COVER	
75	025518 21100	GASKET	
76	025516 21100	GASKET	
77	022802 21100	FILTER HOLDER	
79	945321 00000	SOCKET HEAD SCREW	
80	946971 00000	STUD	
81	947504 00000	WASHER	
82	947104 00000	HEX.NUT	
83	952019 00000	LOCATING PEG	
85	025514 21100	GASKET	
86	025515 21100	GASKET	
88	560203 21100	COOLER	
91	909510 00000	FILTER CARTRIDGE C 713 (1x) ²⁾	
93	946965 00000	STUD	
94	947105 00000	HEX.NUT	
95	949450 00000	WASHER	
97	950304 00000	WASHER	
98	945322 00000	SOCKET HEAD SCREW	
103	068801 21100	COVER	
104	025513 21100	GASKET	
105	945319 00000	SOCKET HEAD SCREW	
110	921500 50000	HANDLE	
121	560204 21100	COOLER	
125	025504 21100	GASKET	



KDT 3.60 - 3.80

Pos.	Ident No.	Description	
126	025512 21100	GASKET	
127	025517 21100	GASKET	
129	945372 00000	SOCKET HEAD SCREW	
130	945328 00000	SOCKET HEAD SCREW	
132	946930 00000	STUD	
134	005602 21100	COVER	
141	016606 21100	CONNECTING PIECE	
146	025507 21100	GASKET	
148	945368 00000	SOCKET HEAD SCREW	
149	741310 30000	RUBBER BUFFER	
161	918300 21100	COVERING HOOD	
163	920800 21100	AIR GUIDE HOOD	
165	960700 21100	VENTILATOR HOOD	
166	960701 21100	VENTILATOR HOOD	
170	945321 00000	SOCKET HEAD SCREW	
171	945371 00000	SOCKET HEAD SCREW	
173	949806 00000	SCREW	
174	951703 00000	SPRING DISC	
175	741302 00000	RUBBER BUFFER	
176	945634 00000	THREADED PIN	
178	951602 00000	RING UNIT	
182	014902 21100	FLANGES	
184	951916 00000	RUBBER BUSHING	
185	948772 00000	PIPE RIVET	
186	947508 00000	WASHER	
188	945333 00000	SOCKET HEAD SCREW	
190	951018 00000	STUD	
191	947506 00000	WASHER	
192	947106 00000	HEX.NUT	
195	902108 00000	COUPLING	
196	902209 00000	COUPLING DISC	
197	544501 21100	COUPLING WITH FAN	
285	728000 99622	PRESSURE REGULATING VALVE / 8,7 PSI	
285	728001 99622	PRESSURE REGULATING VALVE / 14,5 PSI	
285	728002 99622	PRESSURE REGULATING VALVE / 29 PSI	
288	948066 00000	SEALING RING	
290	964307 00000	SILENCER TUBE	
291	912805 00000	PLUG	
400	769302 40840	FREQUENCY CONVERTOR	
401	961301 19600	GASKET	
402	945315 00000	SOCKET HEAD SCREW	



GREASE 960000 02300 AMBLYGON TA15/2 (TUBE, 8g)

¹⁾ Set of seals - 54900021100 - Pos.: 20, 24, 62, 75, 76, 85, 86, 104, 125, 126, 127, 146, 288

²⁾ necessary order quantity / maintenance

OPTIONAL

KDT 3.60	USA	all types
KDT 3.80	/0-05	Special design – corrosion protection
	/0-34	Special design –> air flow rate
	/0-52	Special design – corrosion protection and special vanes
	/0-54	Special design – refrigeration
	/0-400	Special design – with frequency convertor
	/6	Special design – corrosion protection
	/B5-200	Special design – motor flange

Items different from standard appliance see appendix (back of drawing)



Pos.	No. Identification	Designation
...	549000 21100	JEU DE JOINTS ¹⁾
6	000100 21600	CORP DE POMPE, KDT 3.60
6	000100 21100	CORP DE POMPE, KDT 3.80
9	020004 21100	PISTON
11	901330 00004	PALETTE DE CHARBON (KIT) ²⁾
15	000801 21100	COUVERCLE
16	000701 21100	COUVERCLE
18	001100 21100	COUVERCLE DE ROULEMENTE
19	001000 21100	COUVERCLE DE ROULEMENTE
20	025511 21100	JOINT
24	911312 00000	JOINT
26	917152 00000	DISQUE DE COMPENSATION
27	906540 00000	BAGUE D'ETANCHEITE P.L'AXE
28	906612 50000	ROULEMENT A BILLES
29	906657 00000	ROULEMENT A BILLES
31	511400 10100	JEU DISQUE DE TOLERANCE
37	945217 00000	VIS HEXAGONALE
38	016801 21100	DISQUE DE SERRAGE
39	949807 00000	VIS
41	945224 00000	VIS HEXAGONALE
42	945222 00000	VIS HEXAGONALE
45	948742 00000	GOUPILLE CYLINDRIQUE
47	947736 00000	CLAVETTE
50	053201 21100	BRIDE DE RACCORDEMENT
52	950308 00000	RONDELLE
53	945337 00000	VIS HEXAGONALE INTERNE
57	949409 00000	RONDELLE
58	945270 00000	VIS BOUT D'ARBRE
61	040101 21100	BOITE POUR FILTRE
62	025501 21100	JOINT
64	946955 00000	TOURILLON
65	951003 00000	PRISONNIER
67	964407 00000	TUBE SILENCIEUX
68	909507 00000	CARTOUCHE FILTRANTE C 1112/2 (1x) ²⁾
71	009000 27000	RESSORT-JAME
72	948750 00000	RIVET AVEUGLIE
73	040201 21100	COUVERCLE DU FILTRE
75	025518 21100	JOINT
76	025516 21100	JOINT
77	022802 21100	SUPPORT FILTRE
79	945321 00000	VIS HEXAGONALE INTERNE
80	946971 00000	PRISONNIER
81	947504 00000	RONDELLE
82	947104 00000	ECROU A 6PANS
83	952019 00000	DOUILLE DE ETRAGE
85	025514 21100	JOINT
86	025515 21100	JOINT
88	560203 21100	REFROIDISSEUR
91	909510 00000	CARTOUCHE FILTRANTE C 713 (1x) ²⁾
93	946965 00000	PRISONNIER
94	947105 00000	ECROU A 6 PANS
95	949450 00000	RONDELLE
97	950304 00000	RONDELLE
98	945322 00000	VIS HEXAGONALE INTERNE
103	068801 21100	COUVERCLE
104	025513 21100	JOINT
105	945319 00000	VIS HEXAGONALE INTERNE
110	921500 50000	POIGNEE
121	560204 21100	REFROIDISSEUR
125	025504 21100	JOINT

Pos.	No. Identification	Designation
126	025512 21100	JOINT
127	025517 21100	JOINT
129	945372 00000	VIS HEXAGONALE INTERNE
130	945328 00000	VIS HEXAGONALE INTERNE
132	946930 00000	PRISONNIER
134	005602 21100	COUVERCLE
141	016606 21100	PIECE RACCORD
146	025507 21100	JOINT
148	945368 00000	VIS HEXAGONALE INTERNE
149	741310 30000	AMORTISSEUR EN CAOUTCHOUC
161	918300 21100	CARTER
163	920800 21100	CAPOT DE CANALISATION DE L'AIR
165	960700 21100	CARTER DE VENTILATEUR
166	960701 21100	CARTER DE VENTILATEUR
170	945321 00000	VIS HEXAGONALE INTERNE
171	945371 00000	VIS HEXAGONALE INTERNE
173	949806 00000	VIS À TÊTE NOYÉE
174	951703 00000	DISQUE DE RESSORT
175	741302 00000	AMORTISSEUR EN CAOUTCHOUC
176	945634 00000	GOUPILLE FILETEE
178	951602 00000	ECROU A ANNEAU
182	014902 21100	BRIDES
184	951916 00000	PROTECTION EN CAOUTCHOUC
185	948772 00000	RIVET TUBE
186	947508 00000	RONDELLE
188	945333 00000	VIS HEXAGONALE INTERNE
190	951018 00000	PRISONNIER
191	947506 00000	RONDELLE
192	947106 00000	ECROU A 6 PANS
195	902108 00000	ACCOUPEMENT
196	902209 00000	DISQUE D'ACCOUPEMENT
197	544501 21100	ACCOUPEMENT AVEC VENTILATEUR
285	728000 99622	SOUPAPE REGLAGE PRESSION / 0,6 BAR
285	728001 99622	SOUPAPE REGLAGE PRESSION / 1,0 BAR
285	728002 99622	SOUPAPE REGLAGE PRESSION / 2,0 BAR
288	948066 00000	JOINT
290	964307 00000	TUBE SILENCIEUX
291	912805 00000	BOUCHON
400	769302 40840	CONVERTISSEUR DE FREQUENCE
401	961301 19600	JOINT
402	945315 00000	VIS HEXAGONALE INTERNE
	GRAISSE 960000 02300	AMBLYGON TA15/2 (TUBE, 8g)

¹⁾ Jeu de joints - 54900021100 - Pos.: 20, 24, 62, 75, 76, 85, 86, 104, 125, 126, 127, 146, 288

²⁾ quantité nécessaire / entretien

EN OPTION

KDT 3.60	USA	Tous les variantes
KDT 3.80	/0-05	Fabrication spéciale – protection contre la corrosion
	/0-34	Fabrication spéciale – > débit volume
	/0-52	Fabrication spéciale – protection contre la corrosion et palette spéciale
	/0-54	Fabrication spéciale – réfrigération
	/0-400	Fabrication spéciale – avec convertisseur de fréquence
	/6	Fabrication spéciale – protection contre la corrosion
	/B5-200	Fabrication spéciale – bride de moteur

Articles divergents vis-à-vis de l'appareil standard, voir annexe (dos du dessin / du plan) 

Pos.	No. Identificazione	Designazione
...	549000 21100	SERIE DI GUARNIZIONE ¹⁾
6	000100 21600	CARCASSA, KDT 3.60
6	000100 21100	CARCASSA, KDT 3.80
9	020004 21100	ROTORE
11	901330 00004	PALETTE DI CHARBONE (KIT) ²⁾
15	000801 21100	COPERCHIO
16	000701 21100	COPERCHIO
18	001100 21100	COPERCHIO CUSCINETTO
19	001000 21100	COPERCHIO CUSCINETTO
20	025511 21100	GUARNIZIONE
24	911312 00000	GUARNIZIONE
26	917152 00000	DISCO COMPENSATORE
27	906540 00000	GUARNIZIONE PER L'ALBERO
28	906612 50000	CUSCINETTO A SFERA
29	906657 00000	CUSCINETTO A SFERA
31	511400 10100	SERIE DISCO GIUOCO
37	945217 00000	VITE ESAGONALE
38	016801 21100	DISCO DI FISSAGGIO
39	949807 00000	VITE
41	945224 00000	VITE ESAGONALE
42	945222 00000	VITE ESAGONALE
45	948742 00000	PERNO
47	947736 00000	CHIAVETTA
50	053201 21100	FLANGIA DI RACCORDE
52	950308 00000	RONDELLA
53	945337 00000	VITE ESAGONALE INTERNA
57	949409 00000	RONDELLA
58	945270 00000	VITE DI CHIUSURA ALBERO
61	040101 21100	CARCASSA DEL FILTRO
62	025501 21100	GUARNIZIONE
64	946955 00000	PRIGIONIERO
65	951003 00000	L'ASTA A VITE
67	964407 00000	TUBO SILENZIATORE
68	909507 00000	CARTUCCIA FILTRO C 1112/2 (1x) ²⁾
71	009000 27000	MOLLA
72	948750 00000	RIVETTO CIECO
73	040201 21100	COPERCHIO FILTRO
75	025518 21100	GUARNIZIONI
76	025516 21100	GUARNIZIONE
77	022802 21100	SUPPORTO FILTRO
79	945321 00000	VITE ESAGONALE INTERNA
80	946971 00000	L'ASTA A VITE
81	947504 00000	RONDELLA
82	947104 00000	DADO ESAGONALE
83	952019 00000	SPINE DI RICONTRIO
85	025514 21100	GUARNIZIONE
86	025515 21100	GUARNIZIONE
88	560203 21100	RAFFREDDATORE
91	909510 00000	CARTUCCIA FILTRO C 713 (1x) ²⁾
93	946965 00000	L'ASTA A VITE
94	947105 00000	DADO ESAGONALE
95	949450 00000	RONDELLA
97	950304 00000	RONDELLA
98	945322 00000	VITE ESAGONALE INTERNA
103	068801 21100	COPERCHIO
104	025513 21100	GUARNIZIONE
105	945319 00000	VITE ESAGONALE INTERNA
110	921500 50000	MANETTA
121	560204 21100	RAFFREDDATORE
125	025504 21100	GUARNIZIONE

Pos.	No. Identificazione	Designazione
126	025512 21100	GUARNIZIONE
127	025517 21100	GUARNIZIONI
129	945372 00000	VITE ESAGONALE INTERNA
130	945328 00000	VITE ESAGONALE INTERNA
132	946930 00000	L'ASTA A VITE
134	005602 21100	COPERCHIO
141	016606 21100	PEZZI RACCORDI
146	025507 21100	GUARNIZIONE
148	945368 00000	VITE ESAGONALE INTERNA
149	741310 30000	AMMORTIZZATORE IN GOMMA
161	918300 21100	CARTER
163	920800 21100	CAPPOTTA DEL CONDOTTA ARIA
165	960700 21100	CAPPOTTA DEL VENTILATORE
166	960701 21100	CAPPOTTA DEL VENTILATORE
170	945321 00000	VITE ESAGONALE INTERNA
171	945371 00000	VITE ESAGONALE INTERNA
173	949806 00000	VITE A TESTA SVASATA
174	951703 00000	DISCO A MOLLA
175	741302 00000	AMMORTIZZATORE IN GOMMA
176	945634 00000	SPINA FILETTATURA
178	951602 00000	GOLFARE CON FORO FILETTATO
182	014902 21100	FLANGE
184	951916 00000	PROTEZIONE IN GOMMA
185	948772 00000	CHIODO TUBOLARE
186	947508 00000	RONDELLA
188	945333 00000	VITE ESAGONALE INTERNA
190	951018 00000	L'ASTA A VITE
191	947506 00000	RONDELLA
192	947106 00000	DADO ESAGONALE
195	902108 00000	GIUNTO
196	902209 00000	DISCO GUINTO
197	544501 21100	GUINTO CON VENTILATORE
285	728000 99622	VALVOLA REGOLAZ.PRESSIONE / 0,6 BAR
285	728001 99622	VALVOLA REGOLAZ.PRESSIONE / 1,0 BAR
285	728002 99622	VALVOLA REGOLAZ.PRESSIONE / 2,0 BAR
288	948066 00000	ANELLO GUARNIZIONE
290	964307 00000	TUBO SILENZIATORE
291	912805 00000	TAPPO DI CHIUSURA
400	769302 40840	CONVERTITORE DI FREQUENZA
401	961301 19600	GUARNIZIONI
402	945315 00000	VITE ESAGONALE INTERNA



GRASSO 960000 02300 AMBLYGON TA15/2 (TUBETTO, 8g)

¹⁾ Serie di guarnizione - 54900021100 - Pos.: 20, 24, 62, 75, 76, 85, 86, 104, 125, 126, 127, 146, 288
²⁾ quantità di ordinazione necessari / manutenzione

OPZIONALE

KDT 3.60	USA	Tutte tipi
KDT 3.80	/0-05	Modello speciale - protezione anti-corrosione
	/0-34	Modello speciale - > flusso in volume
	/0-52	Modello speciale - protezione anti-corrosione e palette speciale
	/0-54	Modello speciale - refrigerazione
	/0-400	Modello speciale - con convertitore di frequenza
	/6	Modello speciale - protezione anti-corrosione
	/B5-200	Modello speciale - flangia del motore

Vedere allegato (retro del disegno) per le posizioni divergenti dall'apparecchio standard



Pos.	No. De pedido	Descripción	
...	549000 21100	JUNTA COMPLETA ¹⁾	
6	000100 21600	CARCASA, KDT 3.60	
6	000100 21100	CARCASA, KDT 3.80	
9	020004 21100	ÉMBOLO	
11	901330 00004	EMPUJADOR (KIT) ²⁾	
15	000801 21100	TAPA LATERAL	
16	000701 21100	TAPA LATERAL	
18	001100 21100	TAPA DE COJINETE LADO A	
19	001000 21100	TAPA DE COJINETE LADO B	
20	025511 21100	JUNTA	
24	911312 00000	MANGUERA DE JUNTA	
26	917152 00000	ARANDELA DE COMPENSACIÓN	
27	906540 00000	ANILLO DE JUNTA DE ÁRBOL	
28	906612 50000	COJINETE DE RODAMIENTO 3205 2RS C3 TA	
29	906657 00000	COJINETE DE RODAMIENTO NU 205ZS	
31	511400 10100	JUEGO DE ARANDELAS DISTANCIADORAS	
37	945217 00000	TORNILLO DE CABEZA HEXAGONAL	
38	016801 21100	ARANDELA TENSORA	
39	949807 00000	TORNILLO AVELLANADO	
41	945224 00000	TORNILLO DE CABEZA HEXAGONAL	
42	945222 00000	TORNILLO DE CABEZA HEXAGONAL	
45	948742 00000	PASADOR ENTALLADO DE AJUSTE	
47	947736 00000	LENGÜETA DE AJUSTE	
50	053201 21100	FAROL	
52	950308 00000	ARANDELA	
53	945337 00000	TORNILLO HEXAGONAL INTERIOR	
57	949409 00000	ARANDELA	
58	945270 00000	TORNILLO TERMINAL DE ÁRBOL	
61	040101 21100	CARCASA DE FILTRO	
62	025501 21100	JUNTA	
64	946955 00000	ESPÁRRAGO	
65	951003 00000	ESPÁRRAGO	
67	964407 00000	TUBO DE SILENCIADOR	
68	909507 00000	CARTUCHO DE FILTRO C 1112/2 (1x) ²⁾	
71	009000 27000	MUELLE DE PRESIÓN	
72	948750 00000	REMACHE CIEGO	
73	040201 21100	TAPA DE FILTRO	
75	025518 21100	JUNTA	
76	025516 21100	JUNTA	
77	022802 21100	SOPORTE DE FILTRO	
79	945321 00000	TORNILLO HEXAGONAL INTERIOR	
80	946971 00000	ESPÁRRAGO	
81	947504 00000	ARANDELA	
82	947104 00000	TUERCA HEXAGONAL	
83	952019 00000	CASQUILLO TENSOR	
85	025514 21100	JUNTA	
86	025515 21100	JUNTA	
88	560203 21100	REFRIGERADOR	
91	909510 00000	CARTUCHO DE FILTRO C 713 (1x) ²⁾	
93	946965 00000	ESPÁRRAGO	
94	947105 00000	TUERCA HEXAGONAL	
95	949450 00000	ARANDELA	
97	950304 00000	ARANDELA	
98	945322 00000	TORNILLO HEXAGONAL INTERIOR	
103	068801 21100	TAPA	
104	025513 21100	JUNTA	
105	945319 00000	TORNILLO HEXAGONAL INTERIOR	
110	921500 50000	EMPUÑADURA	
121	560204 21100	REFRIGERADOR	
125	025504 21100	JUNTA	

Pos.	No. De pedido	Descripción	
126	025512 21100	JUNTA	
127	025517 21100	JUNTA	
129	945372 00000	TORNILLO HEXAGONAL INTERIOR	
130	945328 00000	TORNILLO HEXAGONAL INTERIOR	
132	946930 00000	ESPÁRRAGO	
134	005602 21100	TAPA	
141	016606 21100	PIEZA DE EMPALME	
146	025507 21100	JUNTA	
148	945368 00000	TORNILLO HEXAGONAL INTERIOR	
149	741310 30000	AMORTIGUADOR DE GOMA	
161	918300 21100	CAPERUZA DE RECUBRIMIENTO	
163	920800 21100	CAPERUZA CONDUCTOR DE AIRE	
165	960700 21100	CAPERUZA DE VENTILADOR	
166	960701 21100	CAPERUZA DE VENTILADOR	
170	945321 00000	TORNILLO HEXAGONAL INTERIOR	
171	945371 00000	TORNILLO HEXAGONAL INTERIOR	
173	949806 00000	TORNILLO AVELLANADO	
174	951703 00000	ARANDELA ELÁSTICA	
175	741302 00000	AMORTIGUADOR DE GOMA	
176	945634 00000	VARILLA ROSCADA	
178	951602 00000	TUERCA DE CÁNCAMO	
182	014902 21100	BRIDA INTERMEDIA	
184	951916 00000	BOQUILLA DE CABLE	
185	948772 00000	REMACHE TUBULAR	
186	947508 00000	ARANDELA	
188	945333 00000	TORNILLO HEXAGONAL INTERIOR	
190	951018 00000	ESPÁRRAGO	
191	947506 00000	ARANDELA	
192	947106 00000	TUERCA HEXAGONAL	
195	902108 00000	MITAD DE ACOPLAMIENTO (MOT)	
196	902209 00000	DISCO DE ACOPLAMIENTO / AMARILLO	
197	544501 21100	ACOPLAMIENTO DE SOPLADO CON VÁLVULA	
285	728000 99622	VÁLVULA REGULADORA DE PRESIÓN / 0,6 BAR	
285	728001 99622	VÁLVULA REGULADORA DE PRESIÓN / 1,0 BAR	
285	728002 99622	VÁLVULA REGULADORA DE PRESIÓN / 2,0 BAR	
288	948066 00000	ANILLO DE JUNTA	
290	964307 00000	TUBO DE SILENCIADOR	
291	912805 00000	TAPÓN DE DESGASTE	
400	769302 40840	CONVERTIDOR DE FRECUENCIA	
401	961301 19600	JUNTA	
402	945315 00000	TORNILLO HEXAGONAL INTERIOR	



GRASA 960000 02300 AMBLYGON TA15/2 (TUBO, 8g)

¹⁾ Junta completa - 54900021100 - Pos.: 20, 24, 62, 75, 76, 85, 86, 104, 125, 126, 127, 146, 288
²⁾ cantidad necesario / mantenimiento

OPCIONAL

KDT 3.60	USA	Versión general
KDT 3.80	/0-05	Versión especial - protección contra la corrosión
	/0-34	Versión especial - > caudal volumétrico
	/0-52	Versión especial - protección contra la corrosión y empujador especial
	/0-54	Versión especial - refrigeración
	/0-400	Versión especial - con convertidor de frecuencia
	/6	Versión especial - protección contra la corrosión
	/B5-200	Versión especial - brida de motor

Para posiciones que derivan del aparato standard véase apéndice (lado trasero del plano)



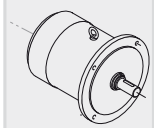

SERVICE ?

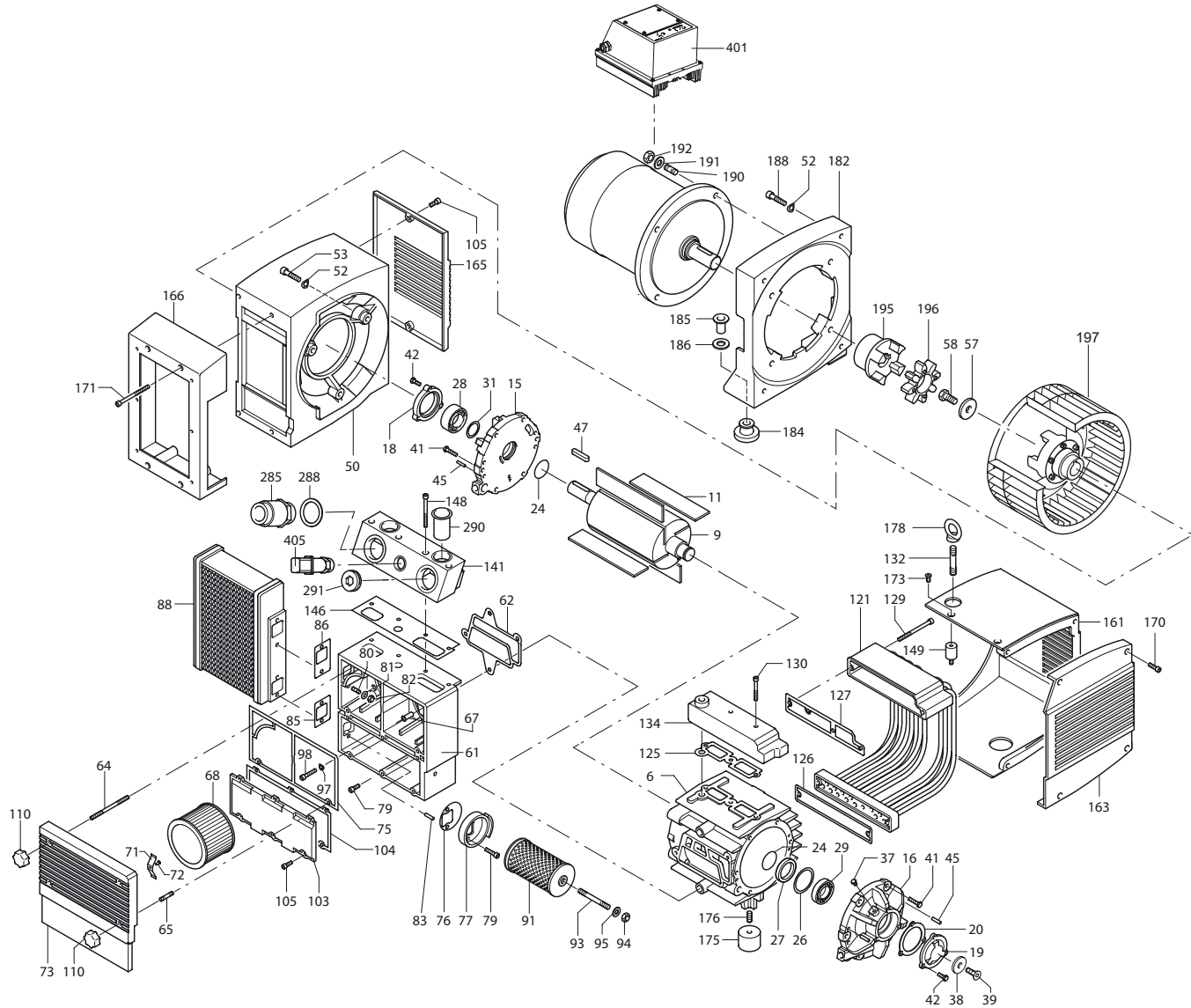
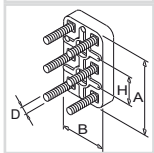
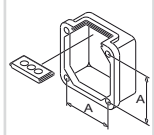
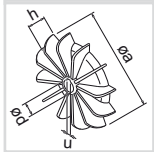
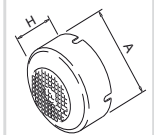





standard

KDT 3.60

KDT 3.80

optional
en option
opcionale
opcional

optional en option optionale opcional 	Variante(n) Modifications Variantes	Pos ³⁾	Bestell Nr. / Ident No. / No. Identification / No. Identificazione / No. De pedido		Beschreibung / Description / Designation / Designazione / Descripcion
					
KDT 3.60/XX KDT 3.80/XX	KDT 3.60 (USA) KDT 3.80 (USA)	190 191 192 195 195		951018-00000 947506-00000 947106-00000 902100-21100 902100-21300	STIFTSCHRAUBE / STUD / PRISONNIER / L'ASTA A VITE / ESPÁRRAGO UNTERLEGSCHLEIBE / WASHER / RONDELLE / RONDELLA / ARANDELA SECHSKANTMUTTER / HEX.NUT / ECROU A 6 PANS / DADO ESAGONALE / TUERCA HEXAGONAL KDT 3.60 - MOTORKUPPLUNG / COUPLING / ACCOUPLEMENT / GIUNTO / ACOPLAMIENTO KDT 3.80 - MOTORKUPPLUNG / COUPLING / ACCOUPLEMENT / GIUNTO / ACOPLAMIENTO
	KDT 3.60/0-05 KDT 3.80/0-05	9	020005 21100	020004-21100	KOLBEN / ROTOR / PISTON / ROTORE / ÉMBOLO
	KDT 3.80/0-34	6 61	000103 21100 040102 21100	000100-21100 040101-21100	GEHÄUSE / PUMP BODY / CORP DE POMPE / CARCASSA / CARCASA FILTERGEHÄUSE / FILTER HOUSING / BOITE POUR FILTRE / CARCASSA DEL FILTRO / CARCASA DE FILTRO
	KDT 3.60/0-52 KDT 3.80/0-52	9 11 285 403	020005 21100 901379 00004 734000 02000	020004-21100 901330-00004 72800X-99622	KOLBEN / ROTOR / PISTON / ROTORE / ÉMBOLO SATZ (KIT) SCHIEBER / VANES / PALETTE / PALETTE / EMPUJADOR DRUCKREGULIERVENTIL / PRESSURE REGULATING VALVE / SOUPAPE REGLAGE PRESSION / VALVOLA REGOLAZIONE PRESSIONE / VÁLVULA REGULADORA DE PRESIÓN DRUCKREGULIERVENTIL 2,2 BAR / PRESSURE REGULATING VALVE 32 PSI / SOUPAPE REGLAGE PRESSION 2,2 BAR / VALVOLA REGOLAZIONE PRESSIONE 2,2 BAR / VÁLVULA REGULADORA DE PRESIÓN 2,2 BAR
	KDT 3.60/0-54 KDT 3.80/0-54	88 166 210 230	560700 21100 019901 21100	560203-21100 960701-21100	KÜHLER / COOLER / REFROIDISSEUR / RAFFREDDATORE / REFRIGERADOR LÜFTERHAUBE / VENTILATOR HOOD / CARTER DE VENTILATEUR / CAPPOTTA DEL VENTILATORE / CAPERUZA DE VENTILADOR LÜFTERHAUBE / VENTILATOR HOOD / CARTER DE VENTILATEUR / CAPPOTTA DEL VENTILATORE / CAPERUZA DE VENTILADOR UMLLENKSTÜCK / RETURN PIECE / PIECE DE RETOUR / PEZZO INVERSIONE / PIEZA DE DESVIACIÓN
	KDT 3.80/0-400	61 141 400 405	040103 21100 016608 21100 769302 41115 769302 42100	040101-21100 016606-21100	FILTERGEHÄUSE / FILTER HOUSING / BOITE POUR FILTRE / CONTENITORE FILTRO / CARCASA DE FILTRO ANSCHLUSS-STÜCK / CONNECTING PIECE / PIECE RACCORD / PEZZI RACCORDI / PIEZA DE EMPALME FREQUENZUMFORMER / FREQUENCY CONVERTOR / CONVERTISSEUR DE FRÉQUENCE / CONVERTITORE DI FREQUENZA / CONVERTIDOR DE FRECUENCIA MESSUMFORMER / MEASUREMENT CONVERTER / CONVERTISSEUR DE MESURE / CONVERTITORE DI MISURA / CONVERTIDOR DE MEDIDA
	KDT 3.60/6 KDT 3.80/6	6 6 9 11 15 000811 21100 16 000711 21100 68 909587 00000	000110 21600 000110 21100 020011 21100 901379 00004 000811 21100 000711 21100 909587 00000	000100-21600 000100-21100 020004-21100 901330-00004 000801-21100 000701-21100 909507-00000	KDT 3.60 - GEHÄUSE / PUMP BODY / CORP DE POMPE / CARCASSA / CARCASA KDT 3.80 - GEHÄUSE / PUMP BODY / CORP DE POMPE / CARCASSA / CARCASA KOLBEN / ROTOR / PISTON / ROTORE / ÉMBOLO SATZ (KIT) SCHIEBER / VANES / PALETTE / PALETTE / EMPUJADOR SEITENDECKEL / LID LATERAL / COUVERCLE LATÉRAL / COPERCHIO LATERALE / TAPA LATERAL SEITENDECKEL / LID LATERAL / COUVERCLE LATÉRAL / COPERCHIO LATERALE / TAPA LATERAL FILTERPATRONE / FILTER CARTRIDGE / CARTOUCHE FILTRE / CARTUCCIA FILTRO / CARTUCHO DE FILTRO
	  KDT 3.60/6-29	9 11 230	020012 21100 901379 00007 019901 21100	020011-21100 901379-00004 019901-21100	KOLBEN / ROTOR / PISTON / ROTORE / ÉMBOLO SATZ (KIT) SCHIEBER / VANES / PALETTE / PALETTE / EMPUJADOR UMLLENKSTÜCK / RETURN PIECE / PIECE DE RETOUR / PEZZO INVERSIONE / PIEZA DE DESVIACIÓN
	KDT 3.60/B5/200	182 195	014900 21600 902100 21600	014900-21100 902100-00000	ZWISCHENFLANSCH / INTERMEDIATE FLANGE / BRIDE INTERMEDIAIRE / FLANGE INTERMEDIA / BRIDA INTERMEDIA MOTORKUPPLUNG / COUPLING / ACCOUPLEMENT / GIUNTO / ACOPLAMIENTO

³⁾ variantenabhängige Bauteile / variant-dependent components / composants variante-dependantes / componenti variante-dispendenti / componentes variante-dependientes